

Capítulo 24 (Luna Rover) Vehículo lunar

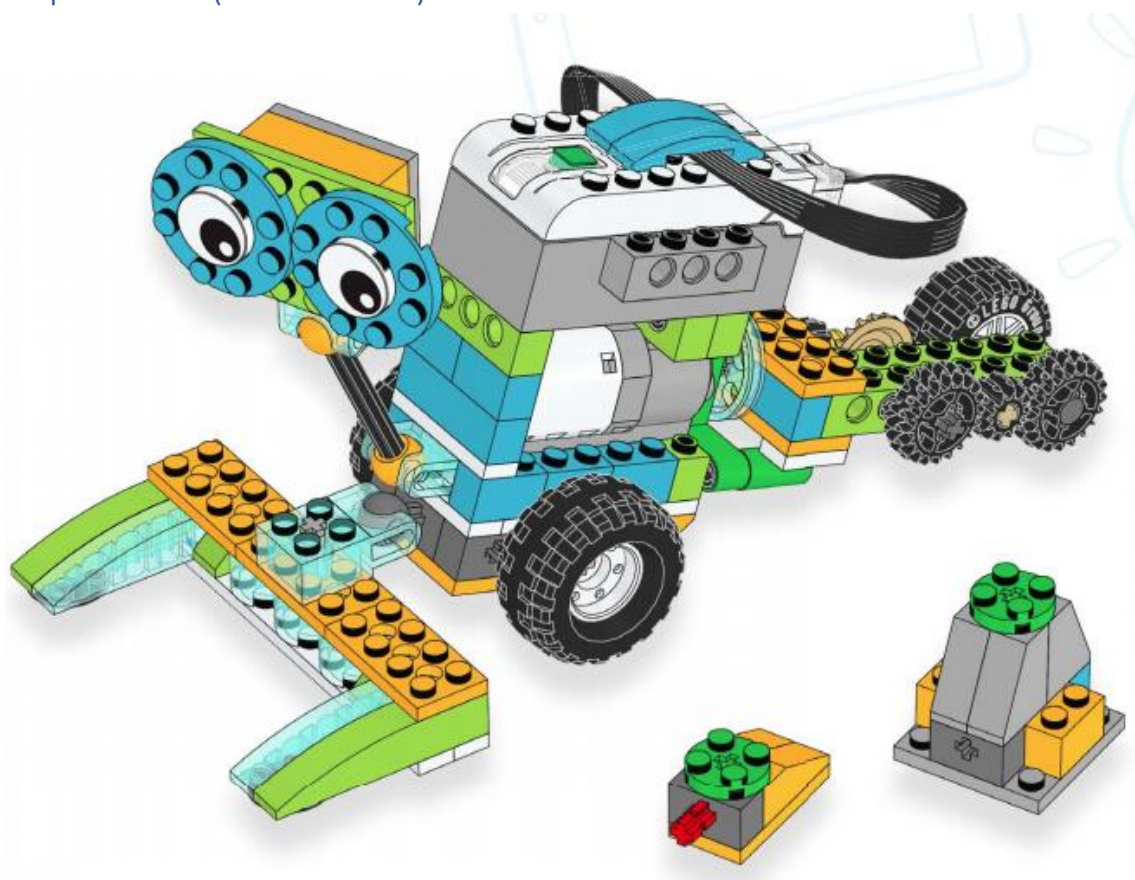

⚠ ADVERTENCIA:
PELIGRO DE ASFIXIA.
Juguete que contiene partes
pequeñas y una pelota pequeña.
No recomendado para niños
menores de 3 años.



Para realizar este capítulo necesitaremos un Kit.

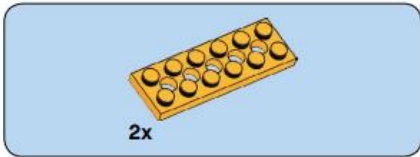

1

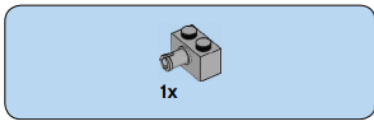
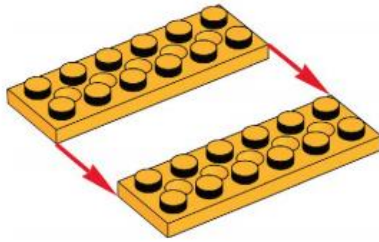

2

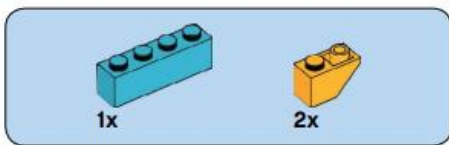
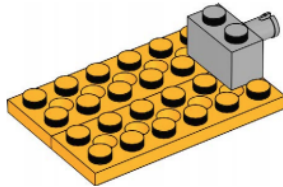

3

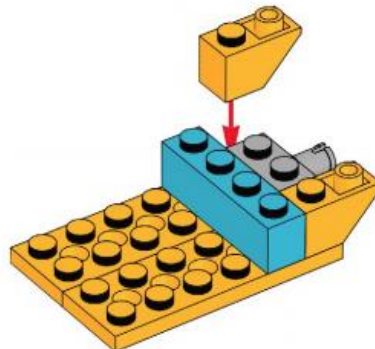

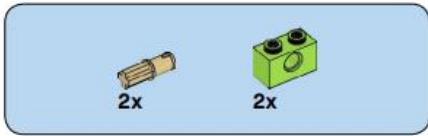

4

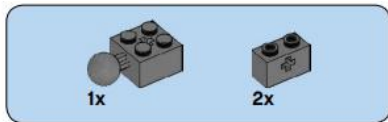
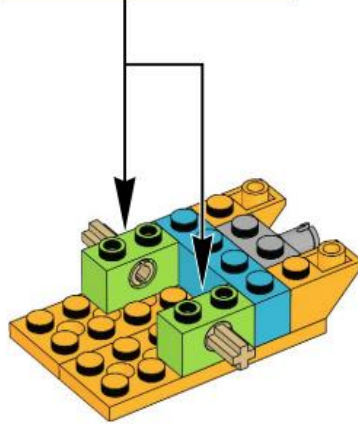
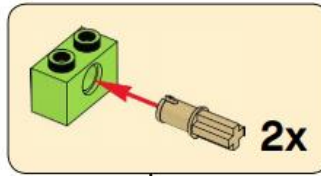

5

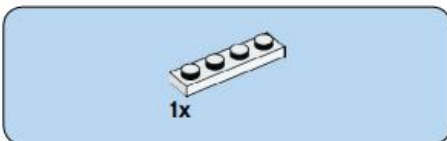
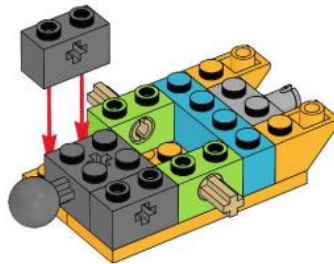

6

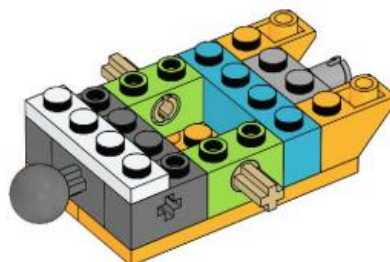

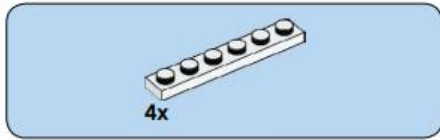

7

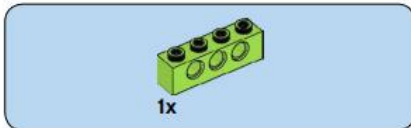
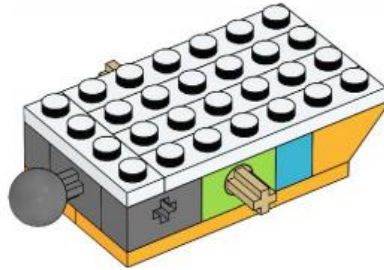

8

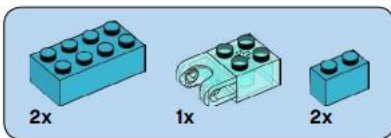
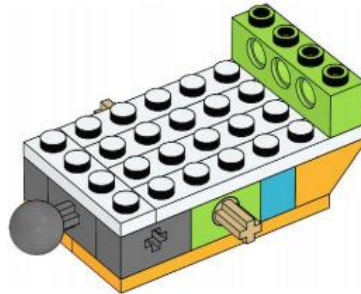

9

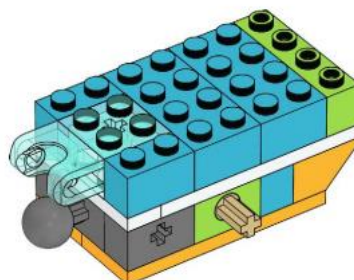

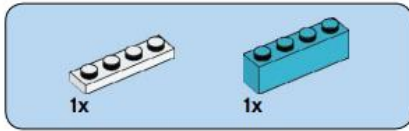

10

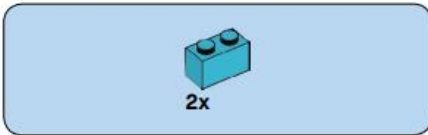
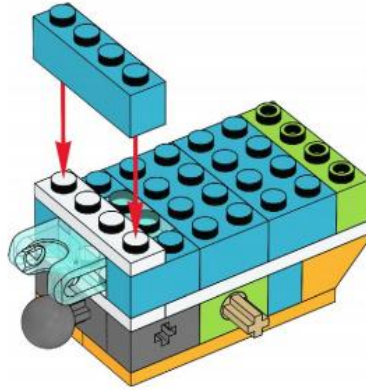

11

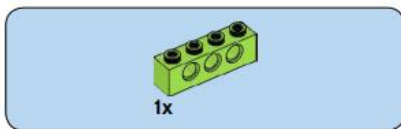
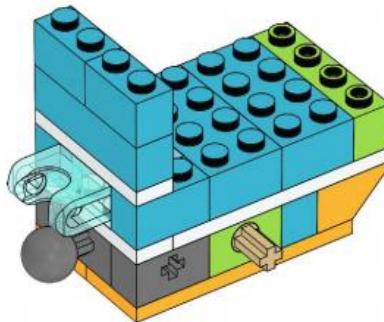

12

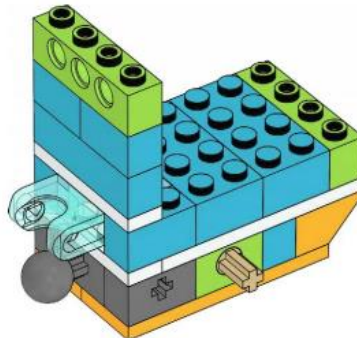

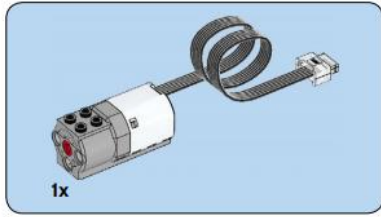

13

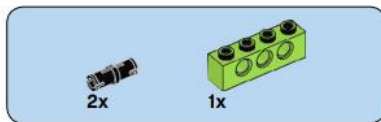
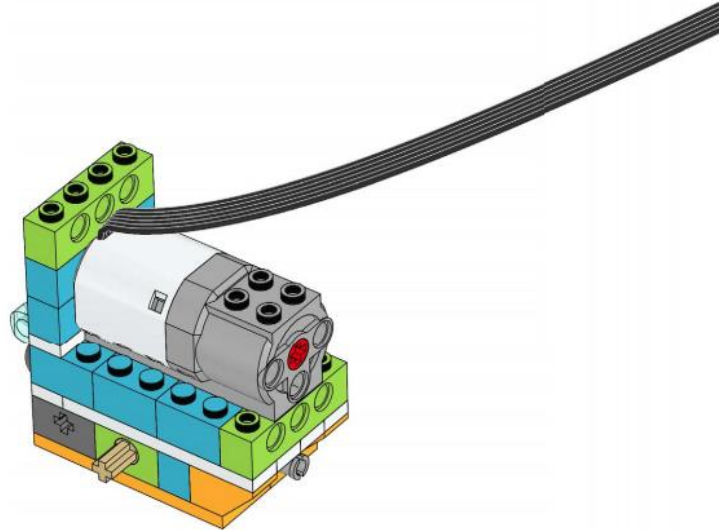

14

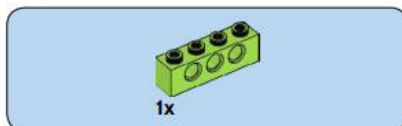
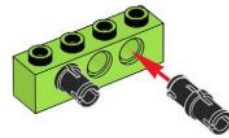

15



16

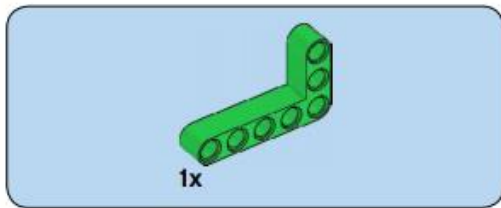
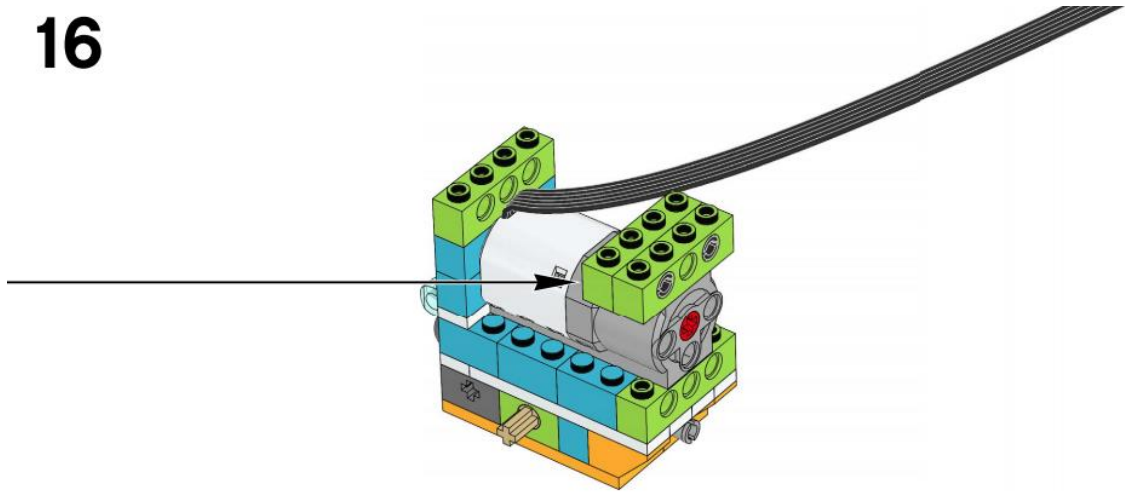

17

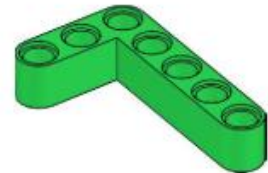

18

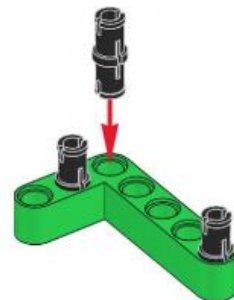

19

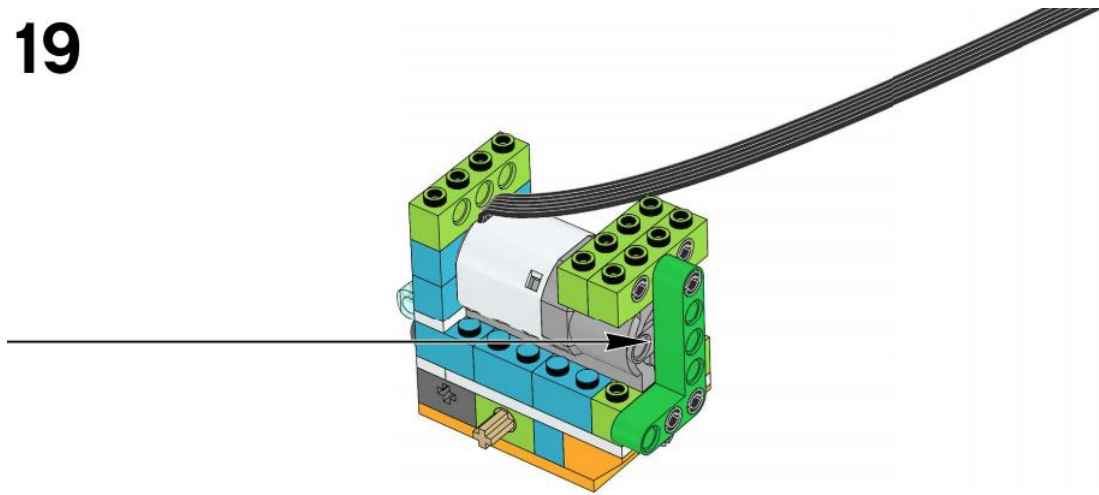

20

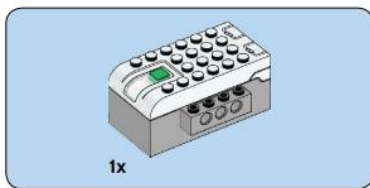
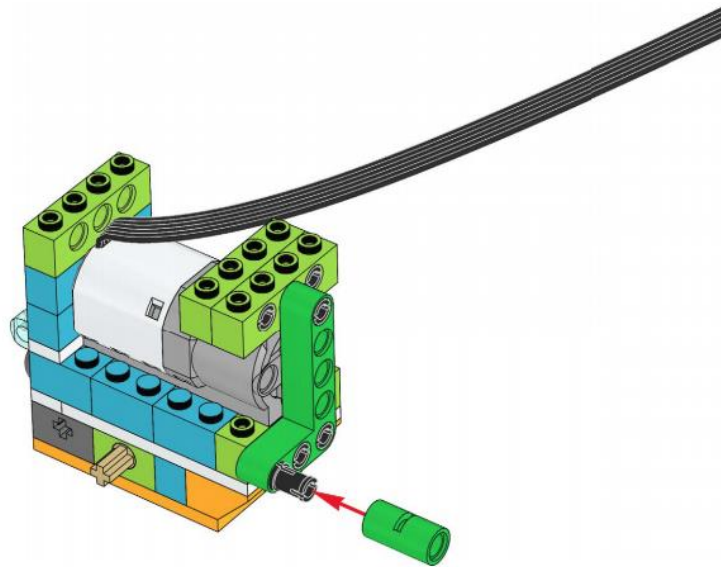

21

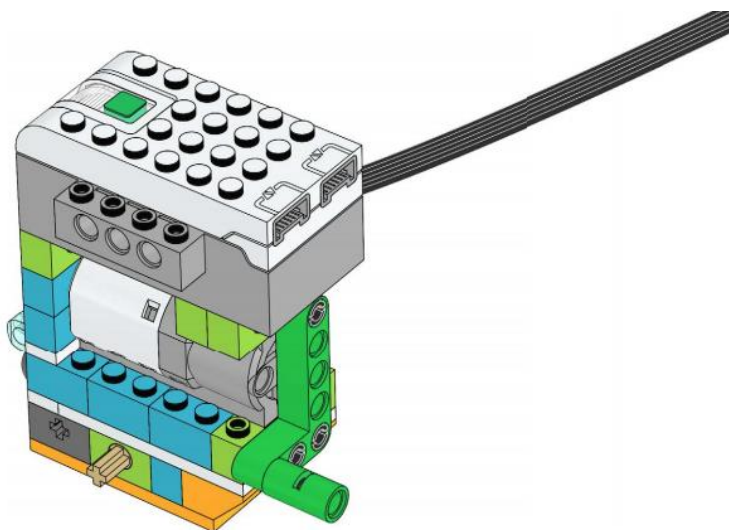

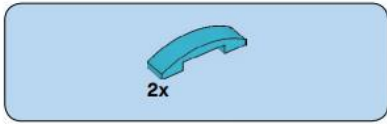

22

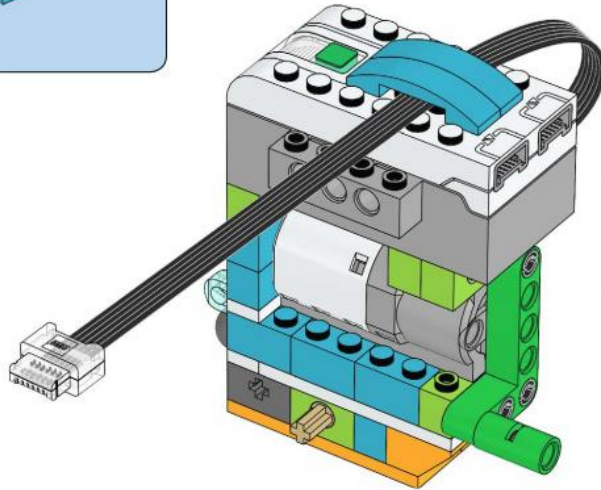

23

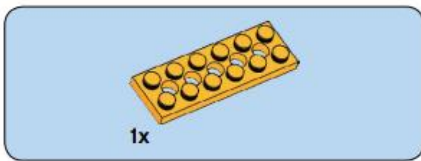
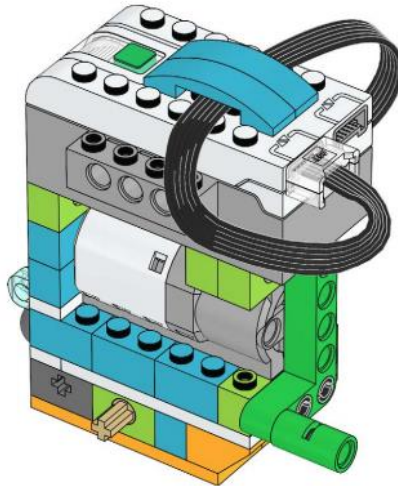

24

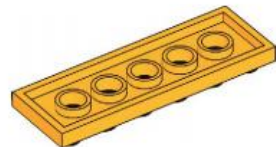

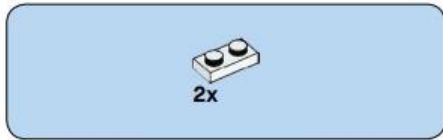

25

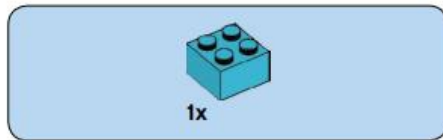
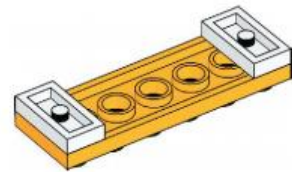

26

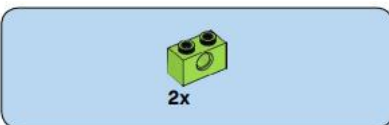
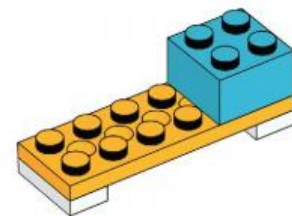

27

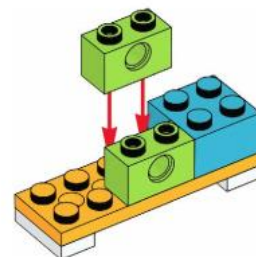

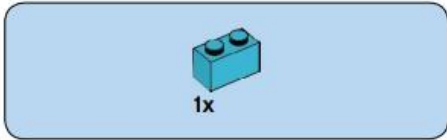

28

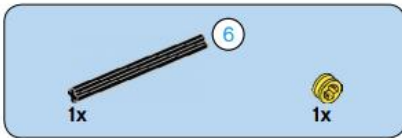
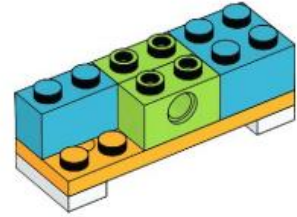

29



30

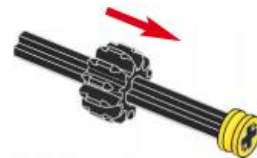

31

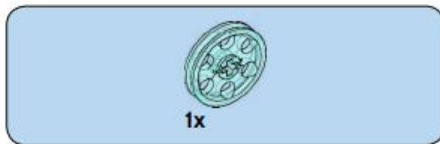

32

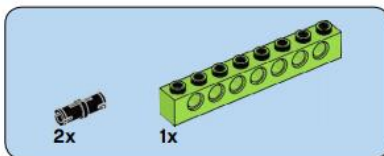
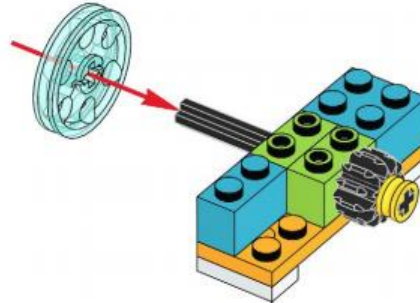

33



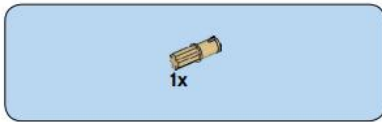

34

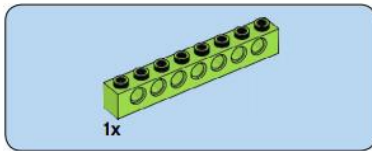
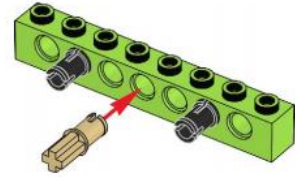

35

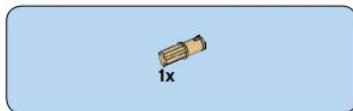

36

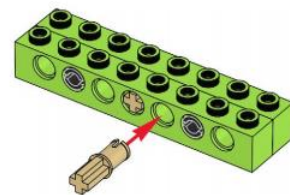



37

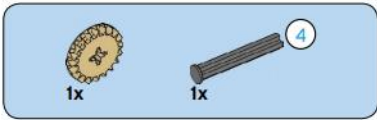
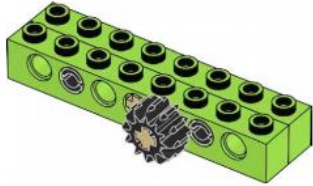

38

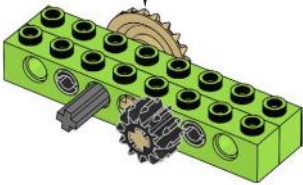
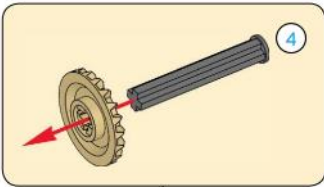

39

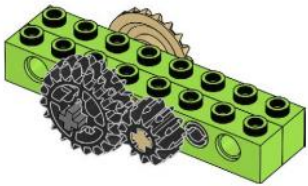

40

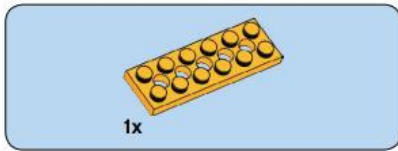
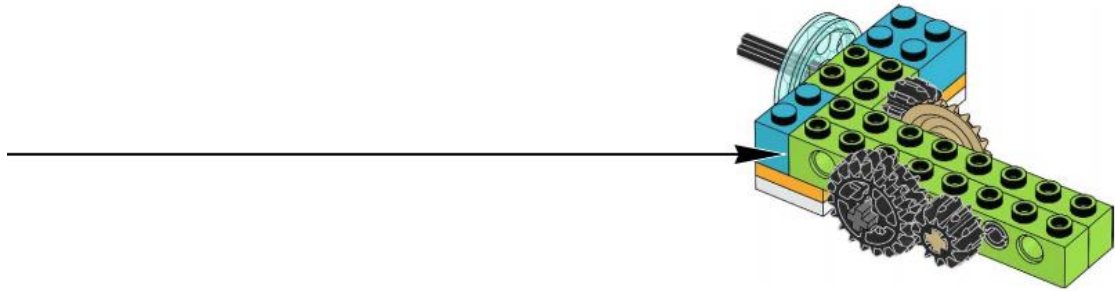

41

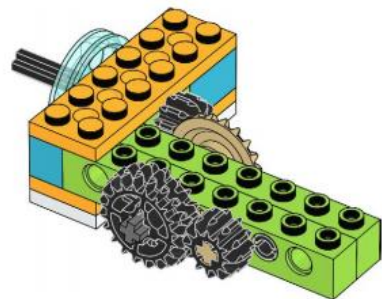

42

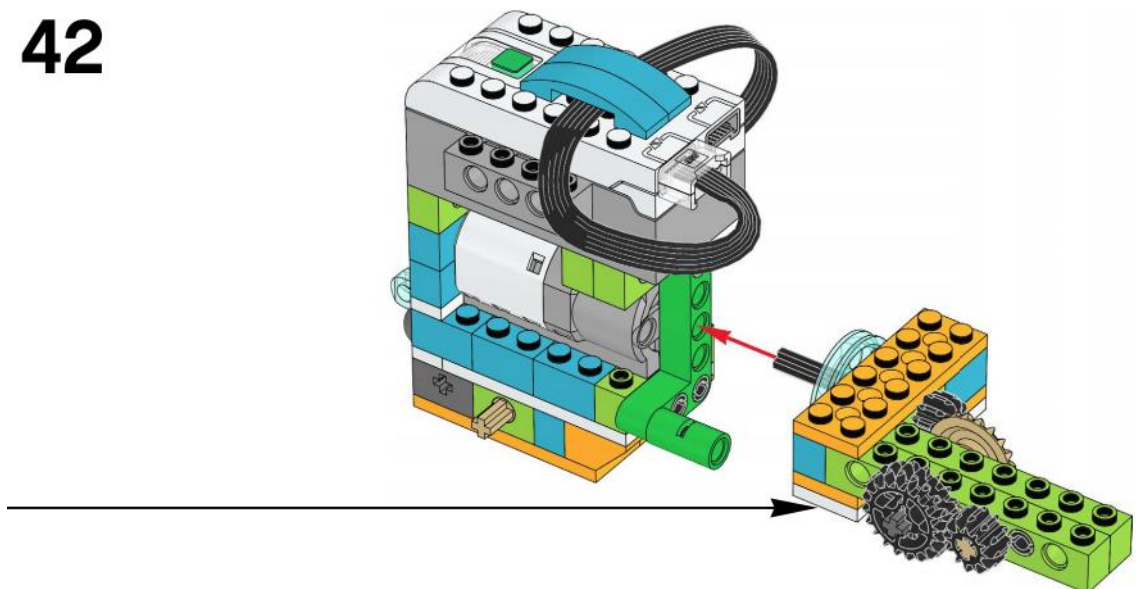

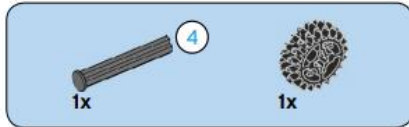

43

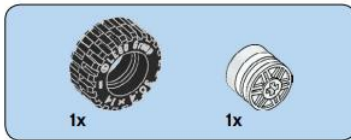
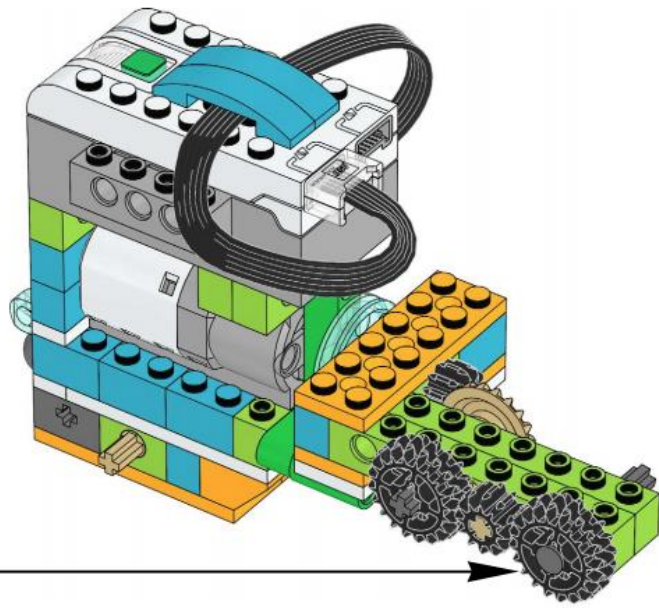
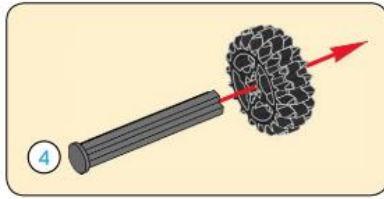

44

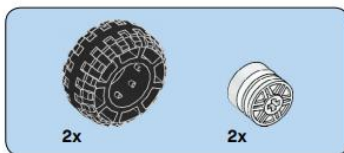
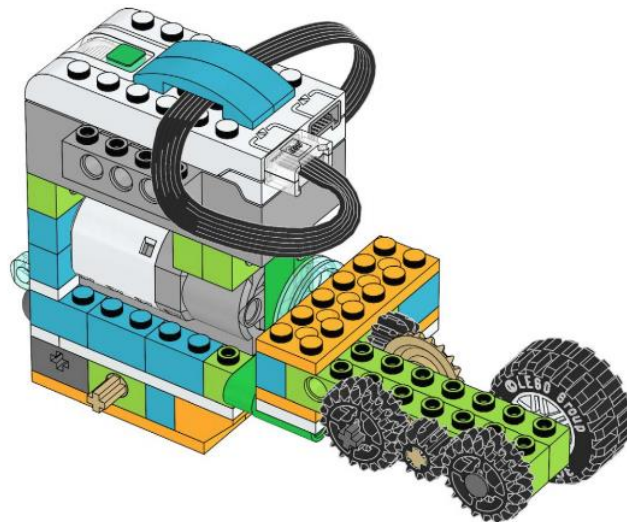

45

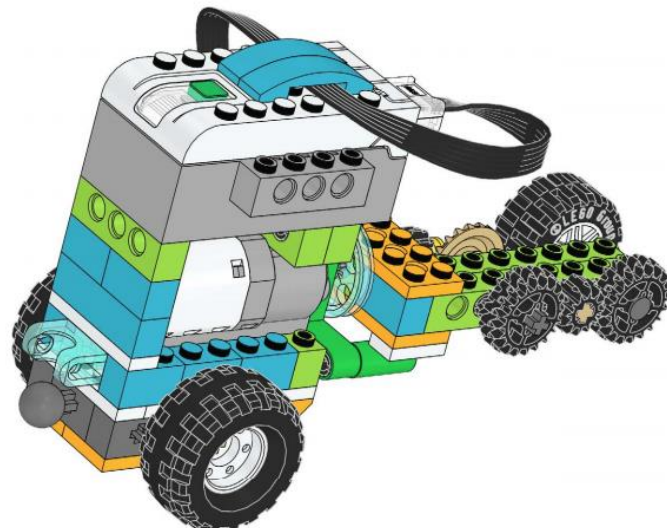

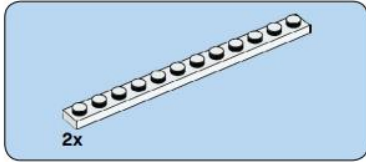

46

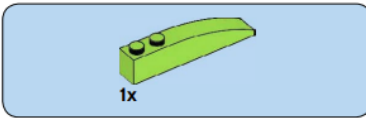

47

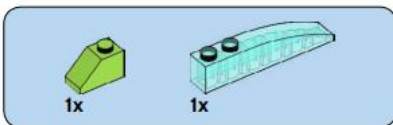
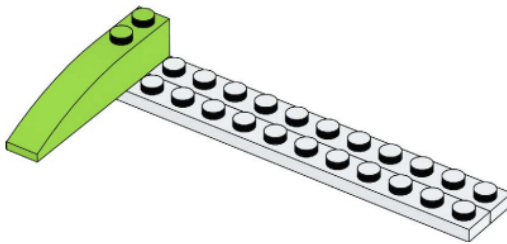

48

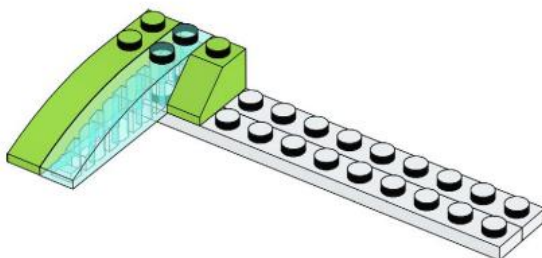

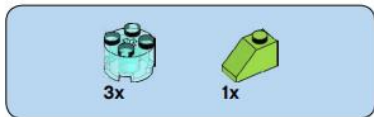

49

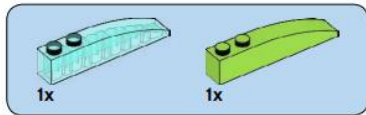
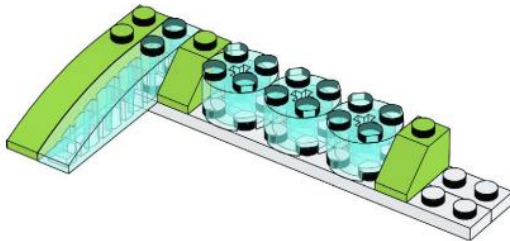

50

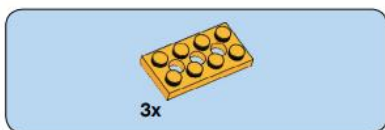
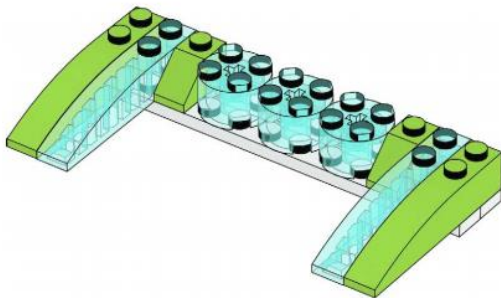

51

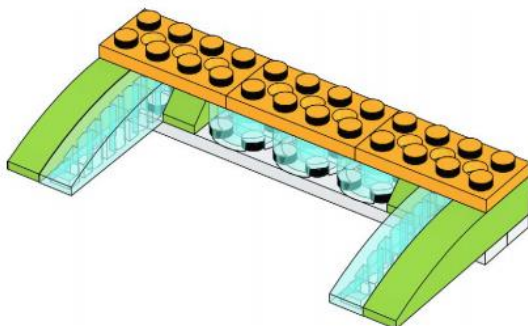



52

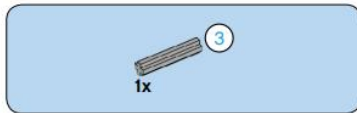
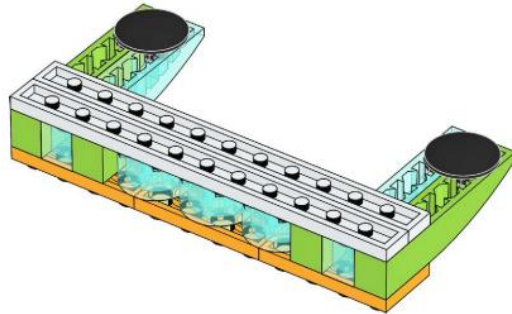

53

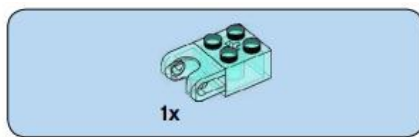
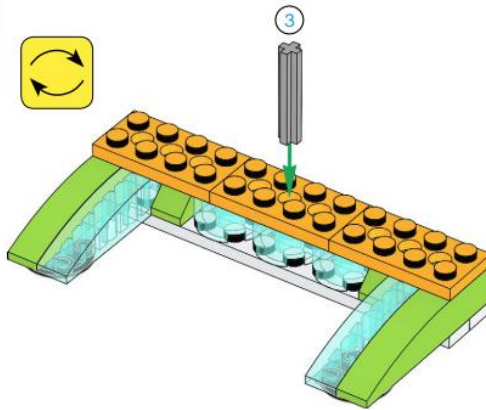

54

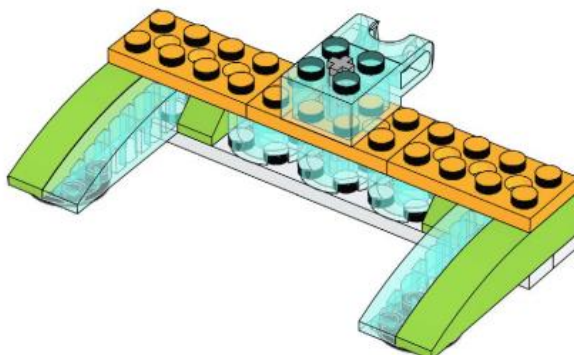

55

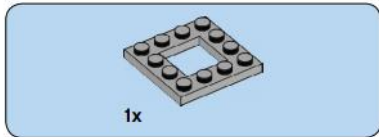
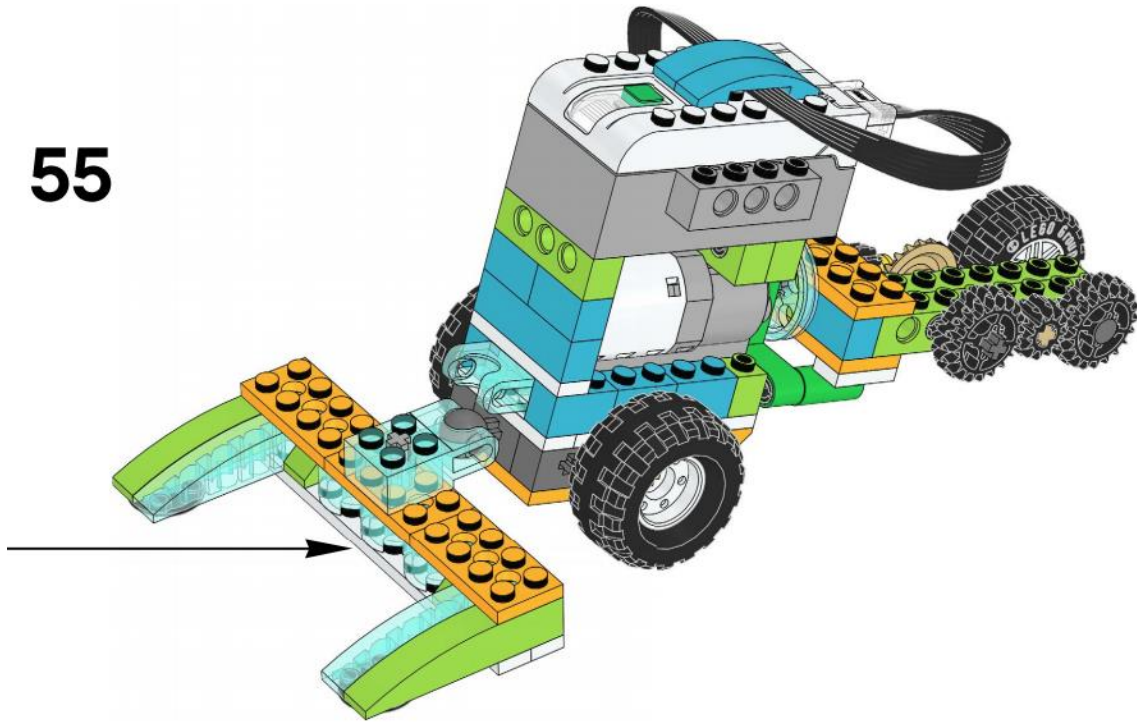

56

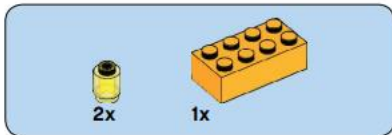
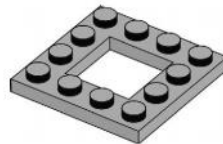

57

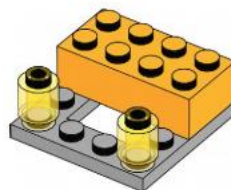

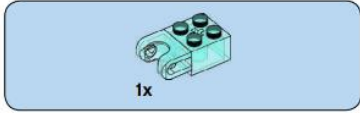

58

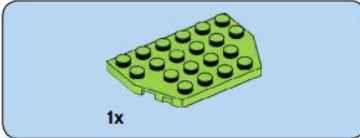
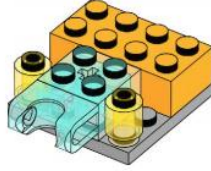

59

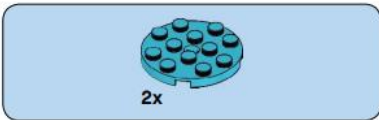
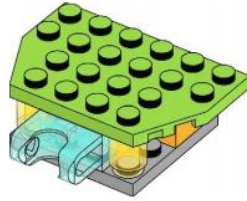

60

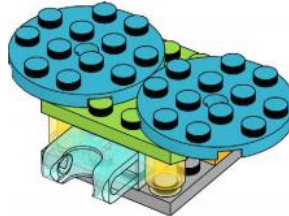

61

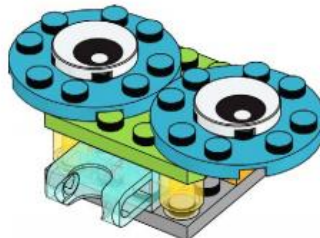

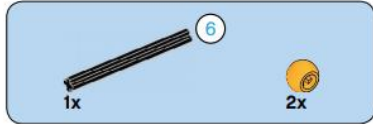

62

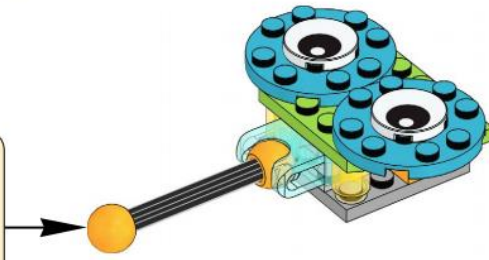
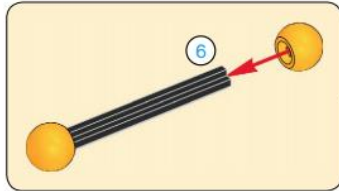

63

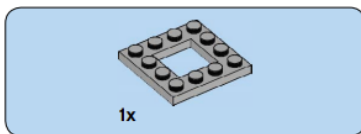
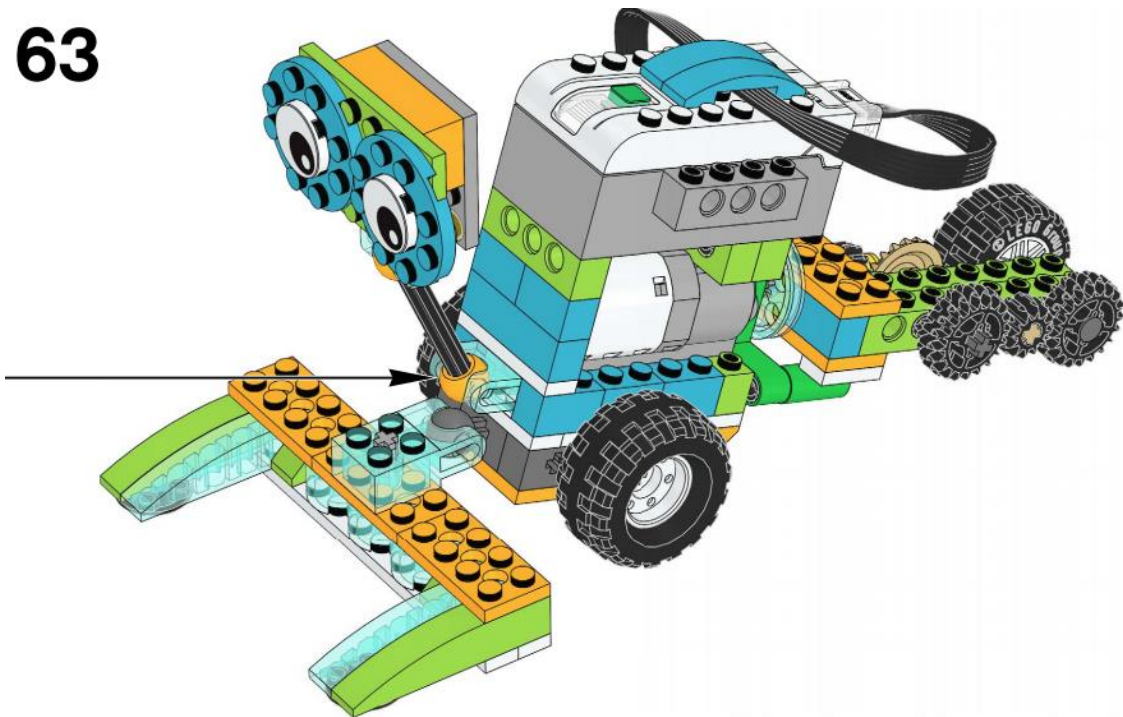

64

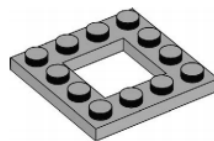

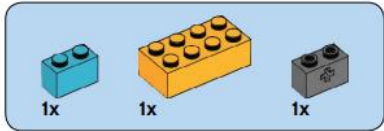

65

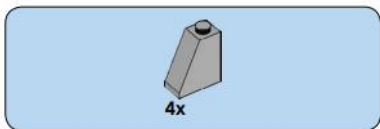
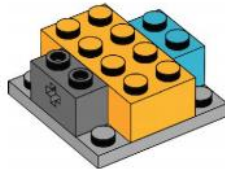

66

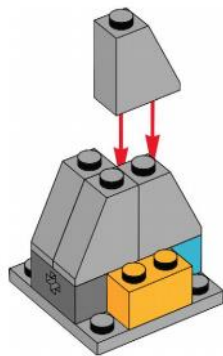

67

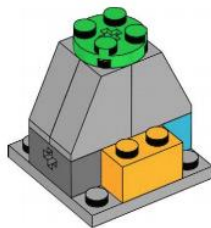

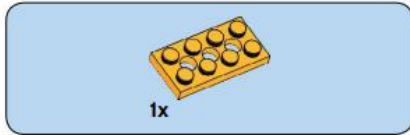

68

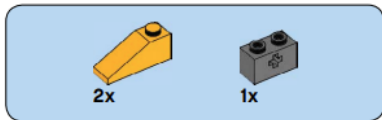
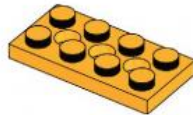

69

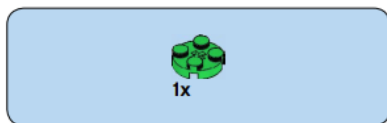
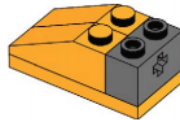

70

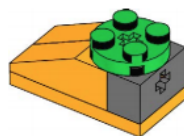

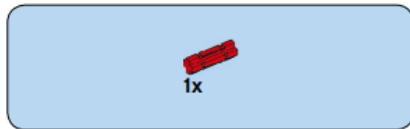

71

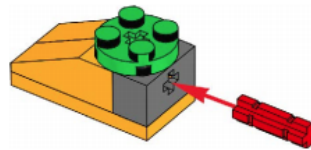

72



Intenta que el recorrido de nuestro robot traslade los objetos.

Codificación

